







a	Walzprofile um starke Achse schmale Walzprofile laminiertes, selon l'axe fort 	$(h-t_f)/b > 1,2$ $t_f \leq 40 \text{ mm}$ walmgerigte Hohlprofile profils creux, finis à chaud 
b	Walzprofile um starke Achse schmale Walzprofile laminiertes, selon l'axe fort 	$t_f \leq 100 \text{ mm}$ schmale Walzprofile um schwache Achse schmale Walzprofile laminiertes, selon l'axe faible 
c	Walzprofile um schwache Achse schmale Walzprofile laminiertes, selon l'axe faible 	$t_f \leq 100 \text{ mm}$ I-Profil geschweisst um starke Achse profils en double té soudés, selon l'axe forte 
d	Walzprofile um beide Achsen massige Flansche, selon les deux axes, alles epais 	$t_f > 100 \text{ mm}$ I-Profil geschweisst um schwache Achse profils en double té soudés, selon l'axe faible 

Seite 24

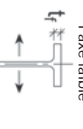
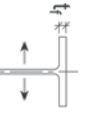
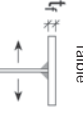
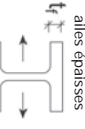
$(h-t_f)/b > 1,2$ $t_f \leq 40 \text{ mm}$ I-Profil geschweisst um starke Achse profils en double té soudés, selon l'axe forte 	geschweisste Kästen allgemein caissons soudés en général 
$t_f \leq 40 \text{ mm}$ I-Profil geschweisst um starke Achse profils en double té soudés, selon l'axe forte 	dickwandige Kästen mit dicken Schweißnähten caissons à parois épaisses avec soudures épaisses 

Seite 99

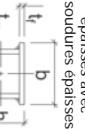
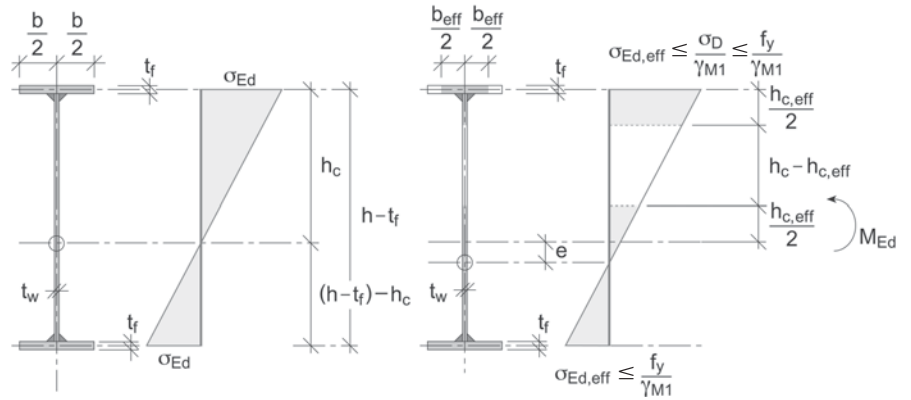
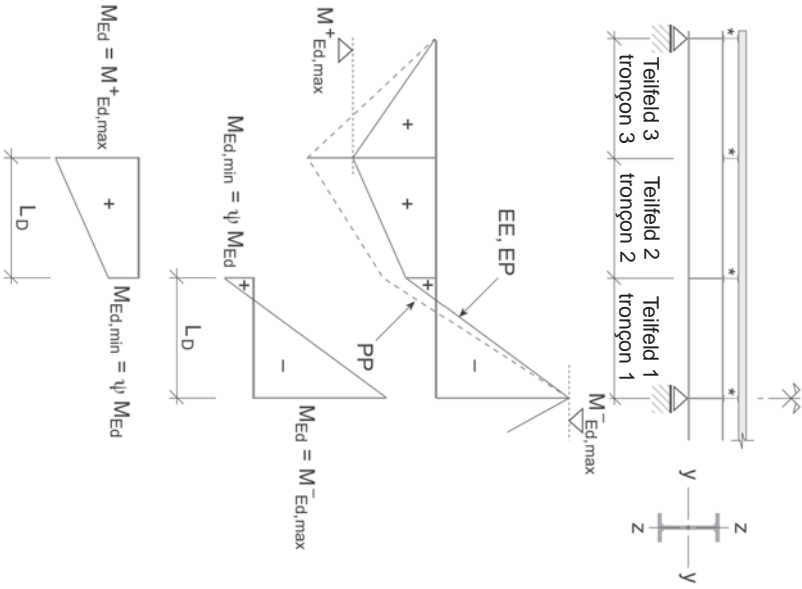

Seite 121

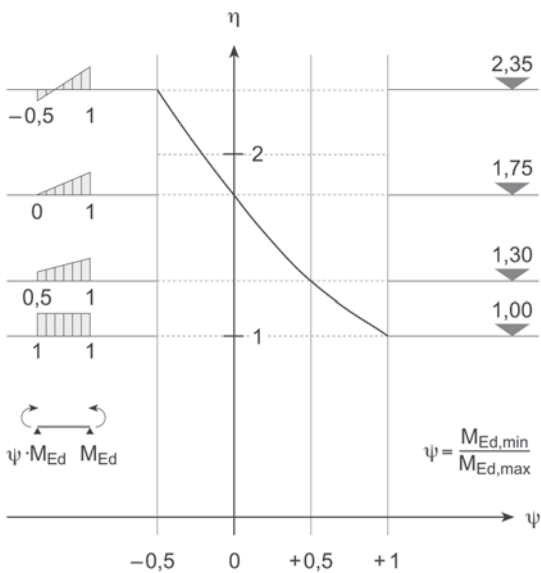

Seite 101

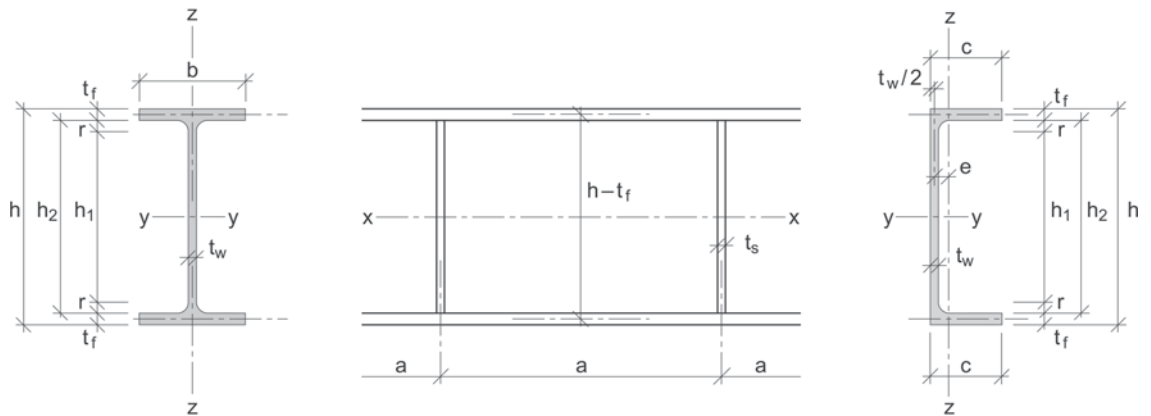

Seite 13