

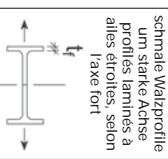

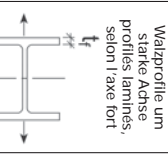
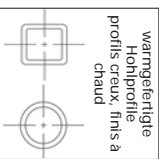
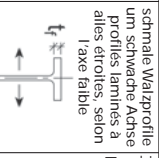
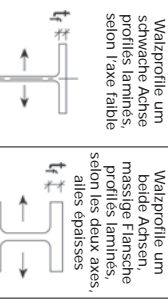
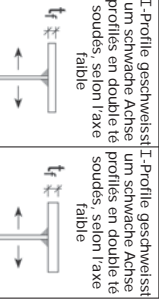

a  schmale Walzprofile um starke Achse profiles laminés a axes étroites, selon l'axe fort $(h-t_f)/b > 1,2$ $t_f \leq 40 \text{ mm}$	 Walzprofile um starke Achse profiles laminés, selon l'axe fort $t_f \leq 100 \text{ mm}$	 Walzprofile um schwache Achse profiles laminés, selon l'axe faible $t_f \leq 100 \text{ mm}$	 Walzprofile um beide Achsen, massige Flansche profiles laminés, selon les deux axes, ailes épaisses $t_f > 100 \text{ mm}$
b geschweißte Kästen allgemein caissons soudés en général $t_f \leq 40 \text{ mm}$	 I-Profil geschweißt um starke Achse profiles en double té soudés, selon l'axe fort $(h-t_f)/b > 1,2$ $t_f \leq 40 \text{ mm}$	 I-Profil geschweißt um starke Achse profiles en double té soudés, selon l'axe fort $t_f \leq 40 \text{ mm}$	 I-Profil geschweißt um schwache Achse profiles en double té soudés, selon l'axe faible $t_f \leq 40 \text{ mm}$
c dickenwandige Kästen mit dicken Schweißnähten caissons à parois épaisses avec soudures épaisses $t_f > 40 \text{ mm}$ $b/t_f < 30$ oder / ou $h/t_w < 30$ $a > 0,5 t_f$	 kaltegerigte Hohlprofile profiles creux, froids $t_f \leq 40 \text{ mm}$	 Vollgerschnitte sections pleines $t_f \leq 40 \text{ mm}$	 I-Profil geschweißt um schwache Achse profiles en double té soudés, selon l'axe faible $t_f > 40 \text{ mm}$

Seite 24

Seite 99

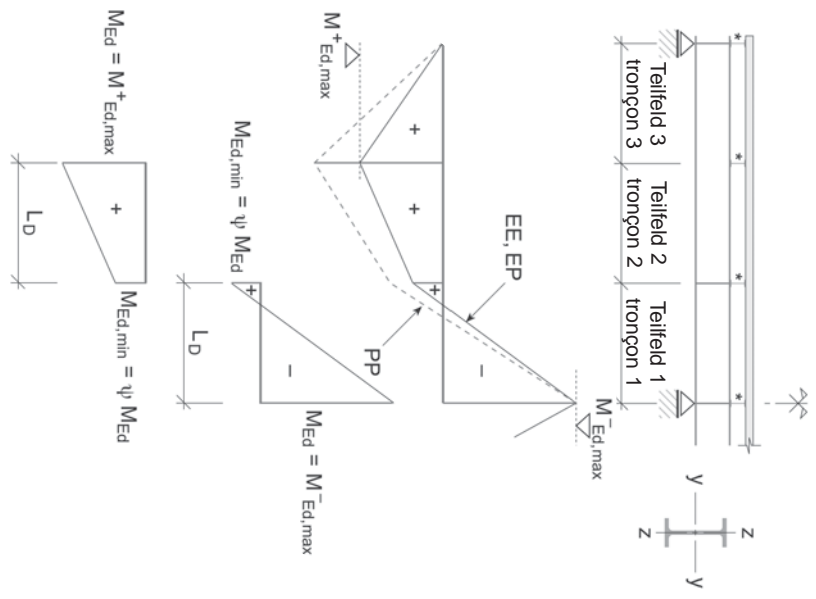

Seite 121

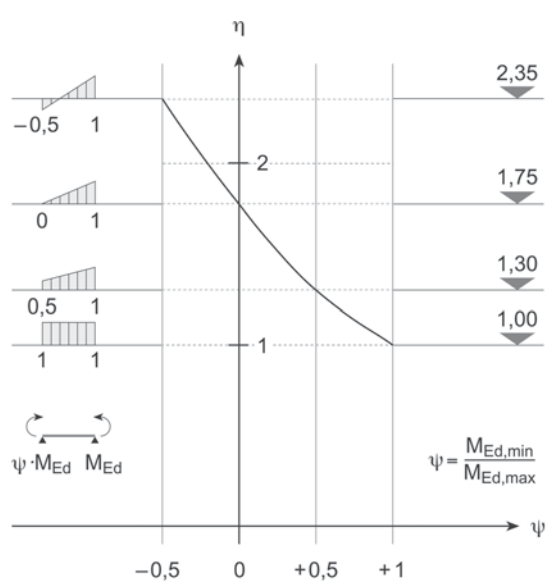
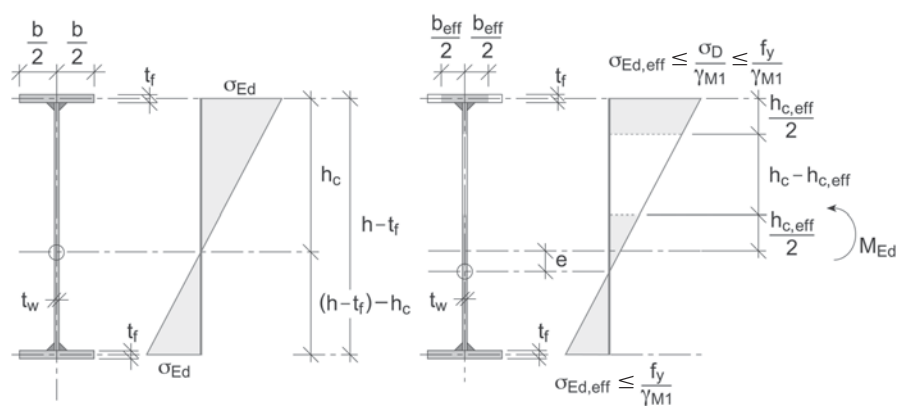

Seite 101

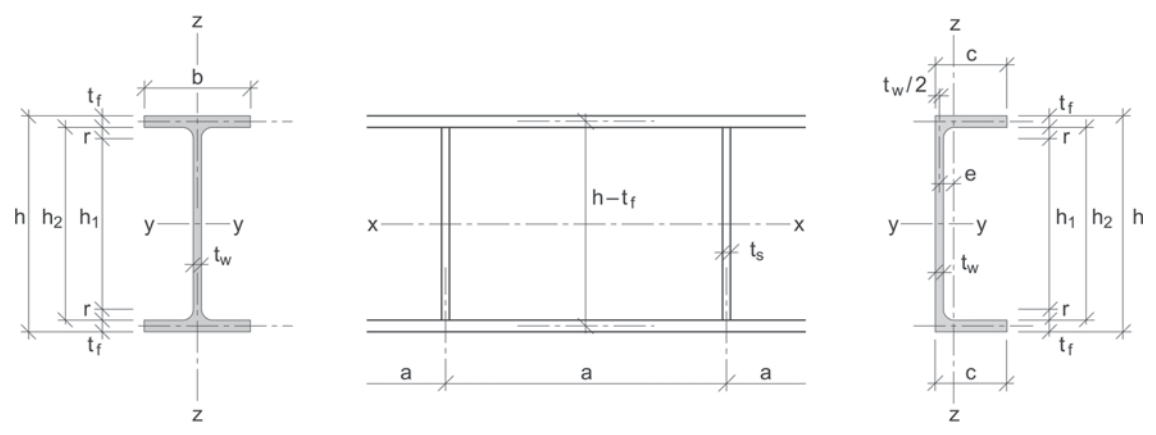

Seite 13